

BATCH CONTROLLER

WITH ONE STAGE CONTROL



Features

- Large display shows preset value and running batch value simultaneously.
- Self-learning overrun correction.
- Easy operation to enter a batch value and to control the process.
- Count-up and count-down function available.
- Selectable on-screen engineering units; volumetric or mass.
- Ability to process all types of flowmeter signals.
- Operational temperature -40°C up to +80°C (-40°F up to 178°F).
- Rugged aluminum field mount enclosure IP67/NEMA4X.
- Intrinsically Safe - ATEX and IECEx approval for gas and dust applications.
- LED backlight option.
- Loop or battery powered, 8 - 24V AC/DC or 115 - 230V AC power supply.
- Sensor supply 3.2 / 8.2 / 12 / 24V DC.

Signal output

- One control output for one-stage batching.

Signal input

Flow

- Reed-switch.
- NAMUR.
- NPN/PNP pulse.
- Sine wave (coil).
- Active pulse signals.

Applications

- For batching small up to very large quantities. Single or repeating batches.

General information

Introduction

The 030 is a straight forward but basic Batch Controller. The operator can enter a batch quantity easily or execute repeating batches. During the batch, the preset value is displayed as well as the batched (or remaining) quantity and the units of measurement. The automatic self-learning overrun correction will ensure an accurate result each batch again. A wide selection of options further enhance this models capabilities, including Intrinsic Safety.

Display

The display has large 17mm (0.67") and 8mm (0.31") digits which are used to display the batched quantity and the preset value simultaneously. On-screen engineering units are easily configured from a comprehensive selection. A seven digit resettable "day total" is available as well as an eleven digit non-resettable accumulated total. All are backed-up in EEPROM memory every minute. A smart display update function achieves a readable display even at -40°C / -40°F.

Backlight

For those applications where readability during day and night is an issue, a bi-color backlight is available. The background color green or amber and the intensity can be adjusted from the keyboard. The display is a transfective type, which means that a high contrast reading is guaranteed in full sunlight as well as during the night. This backlight option is available Intrinsically Safe.

Configuration

All configuration settings are accessed via a simple operator menu which can be pass-code protected. Each setting is clearly indicated with an alphanumeric description, therefore avoiding confusing abbreviations. Once familiar with one F-series product, you will be able to program all models in the series without a manual. All settings are safely stored in EEPROM memory in the event of sudden power failure.

Control output

One output is available for one stage control of smaller batchvolumes. The output signal can be a passive NPN or an active PNP transistor, or an isolated electro-mechanical relay.

Signal input

The 030 will accept most pulse and analog input signals for flow or mass flow measurement. The input signal type can be selected by the user in the configuration menu without having to adjust any sensitive mechanical dip-switches, jumpers or trimmers. The analog input version is even available as 4 - 20mA input loop powered display.

Power supply

Several power supply options are available to power the 030 and sensor. A battery powered version with a long life lithium battery which will last up to five years. For analog sensors, a 4 - 20mA loop powered version is available as well. A real sensor supply is offered with the 24V AC / DC or 115 - 230V AC power supply option.

Hazardous area

This model has been ATEX and IECEx certified Intrinsically Safe for gas and dust applications, with an allowed operational temperature of -40°C to +70°C (-40°F to +158°F).

Enclosures

There are three types of enclosures available: The GA Round Charcoal (Macnaught) version and the GC Round Red version are available with 3 x 1/2" NPT cable gland entry thread or 2xM16 & 1xM20 cable gland entry thread. The third enclosure is the GB enclosure which is available in GRP (Glassfiber Reinforced Polyamide) or Aluminum. For the cable gland entry available see page 6.

Overview application 030

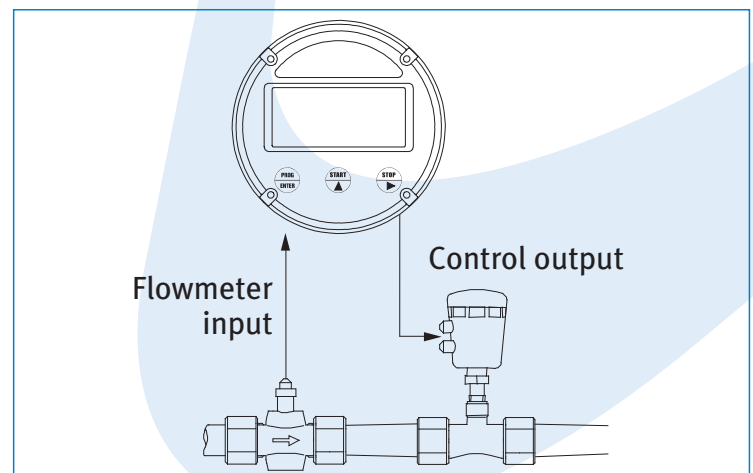

Dimensions enclosures

Aluminum round field / wall mount enclosure HR



Terminal connections power supply PB/PC - PD - PL - PX

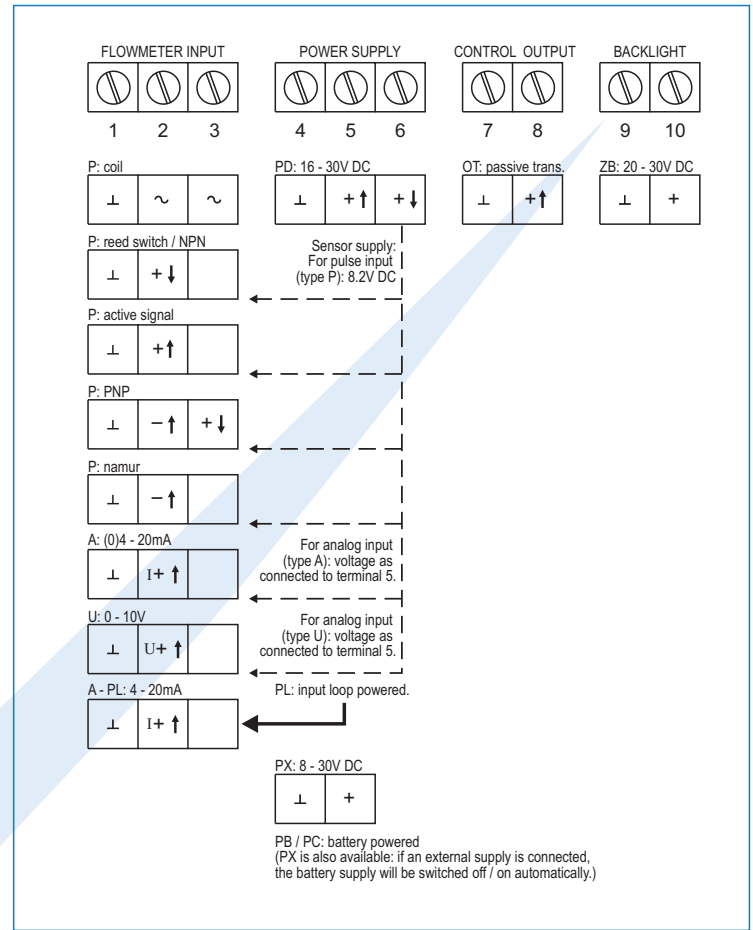

Aluminum & GRP field / remote RA & RG

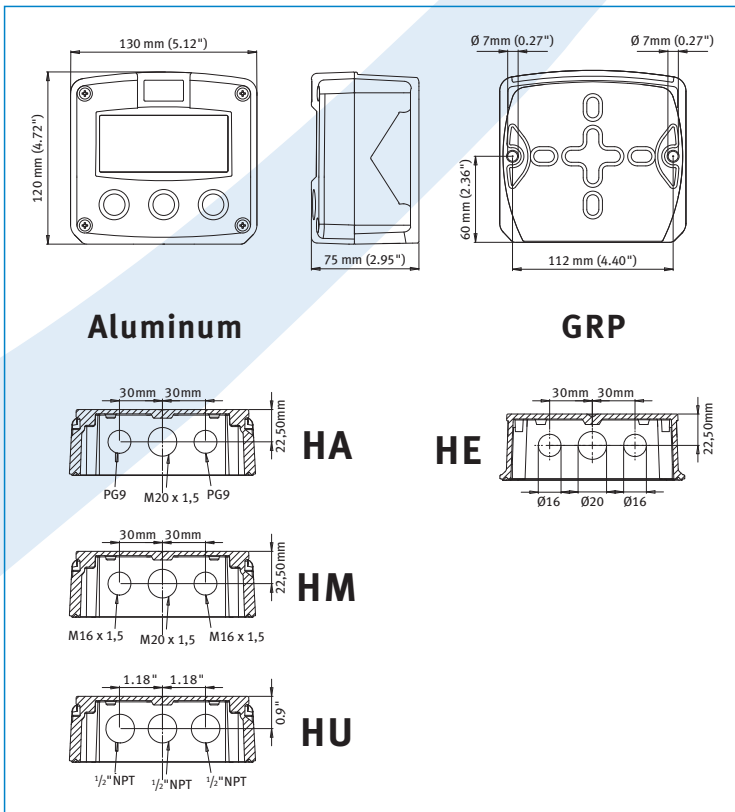

Terminal connections power supply PF - PM

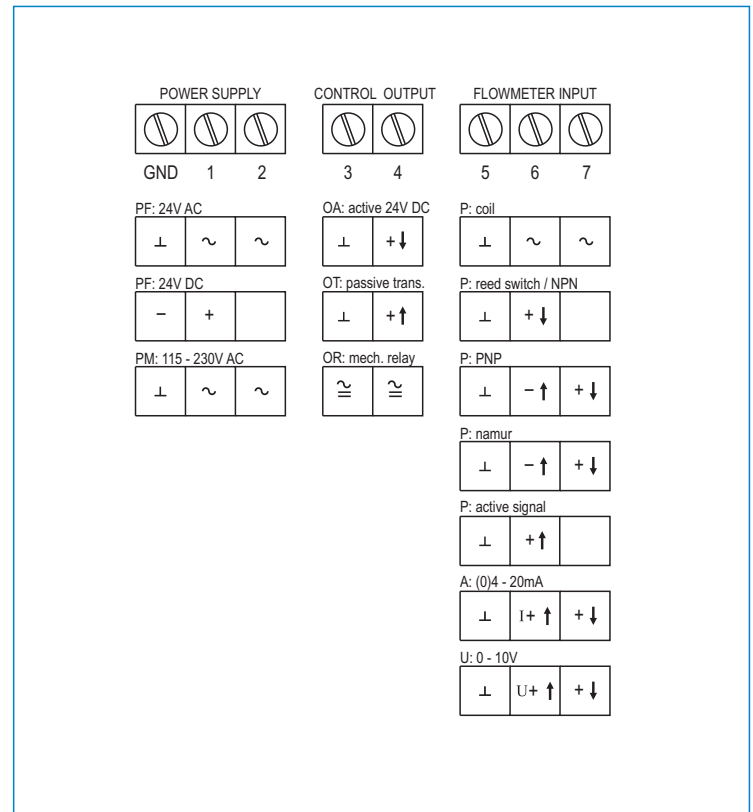

Typical wiring diagram 030-P-OT-PB-(PX)-(ZB)

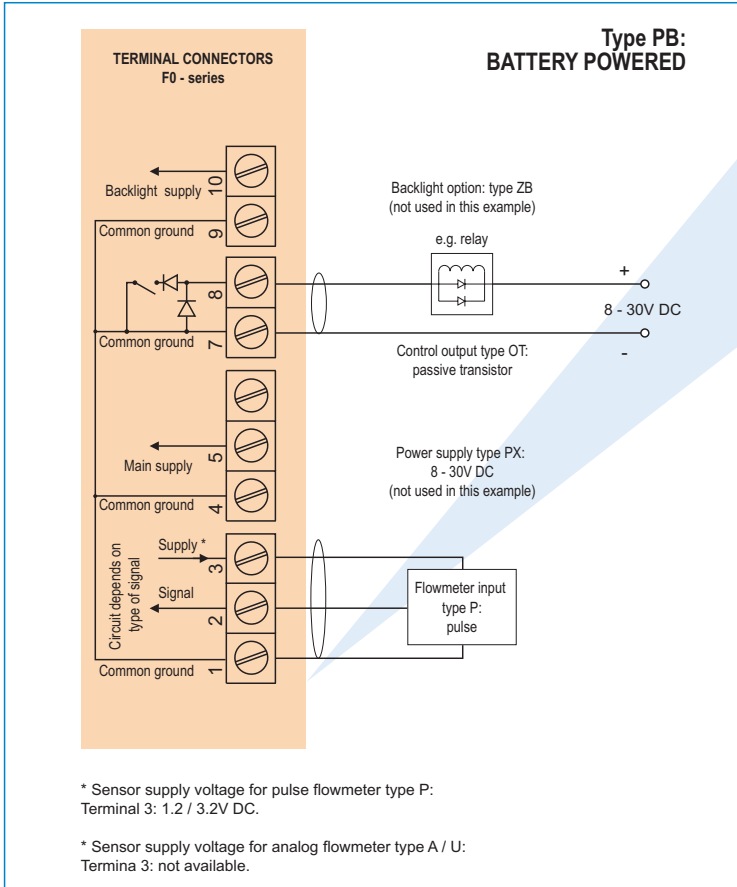

Typical wiring diagram 030-A-OT-PX-ZB

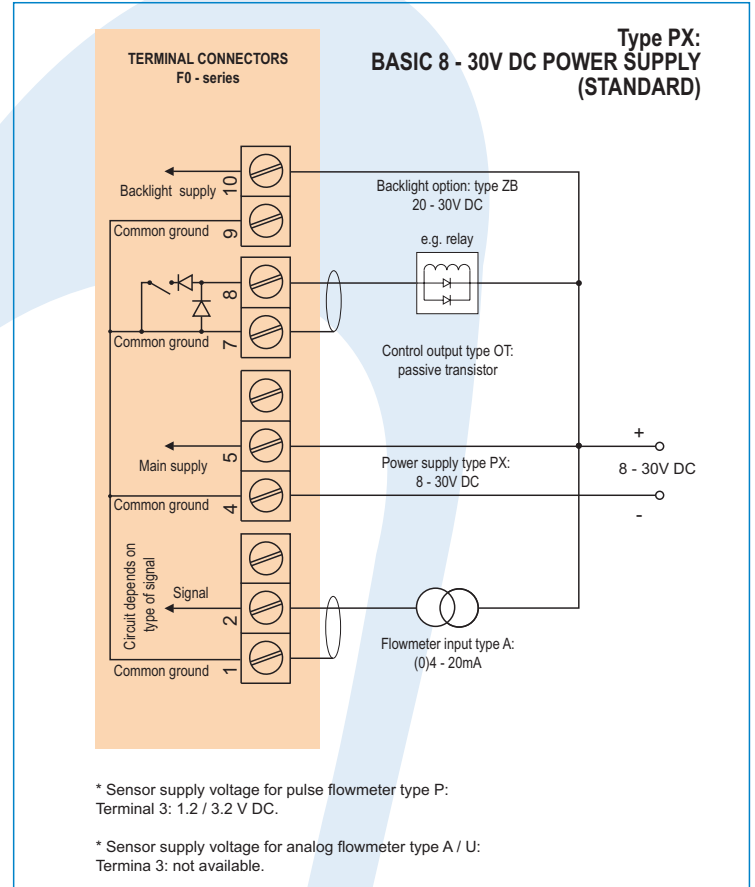

Typical wiring diagram 030-A-OT-PL-(ZB)

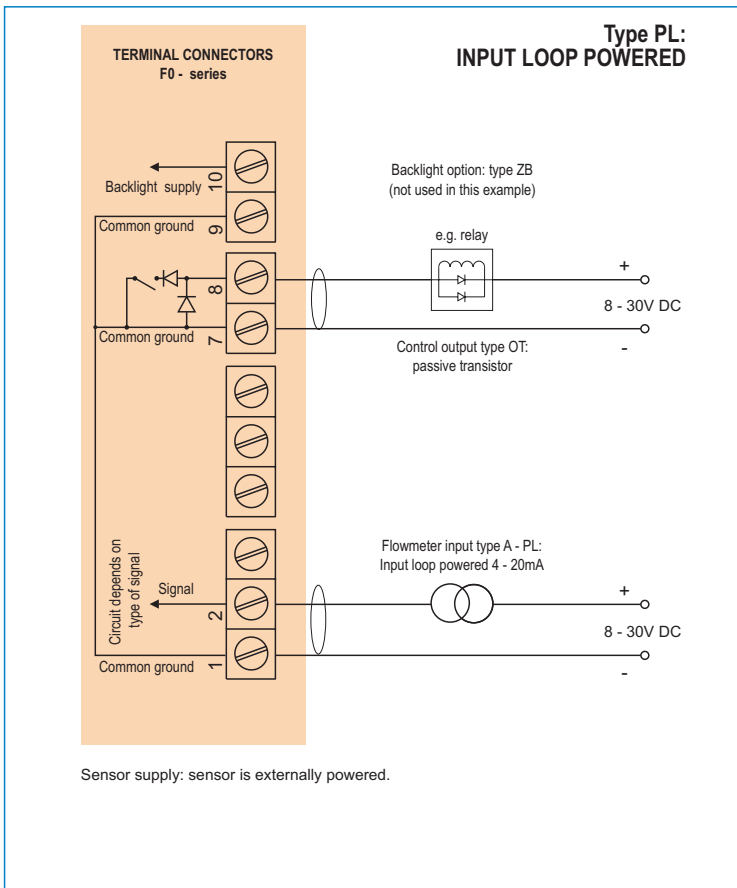

Typical wiring diagram 030-P-OT-PD-ZB

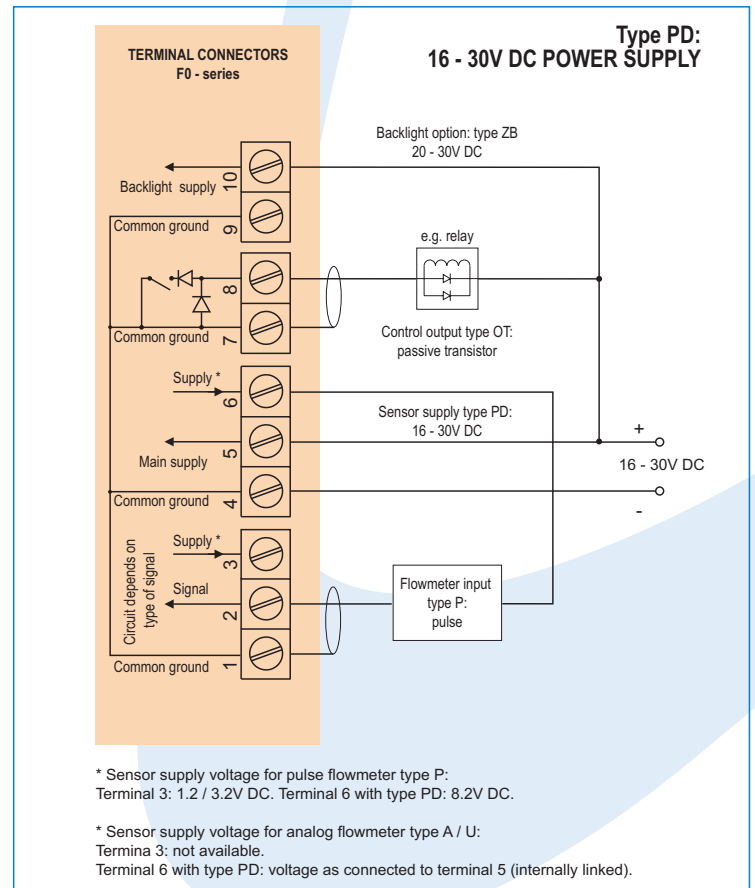

Typical wiring diagram 030-P-OA-PF-ZB

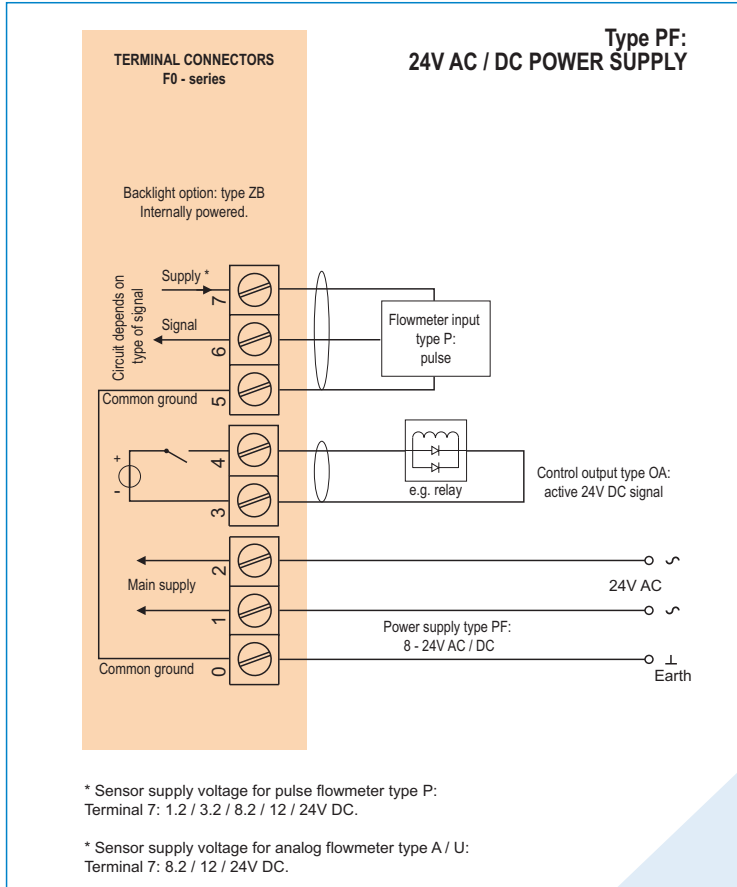

Typical wiring diagram 030-A-OR-PF-ZB

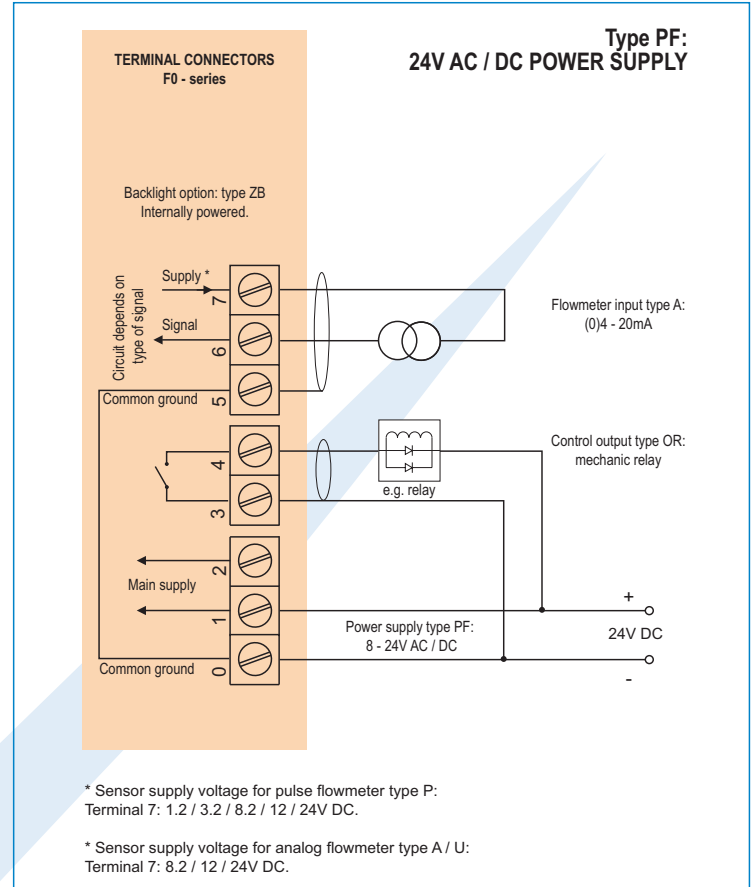

Typical wiring diagram 030-A-OA-PM-ZB

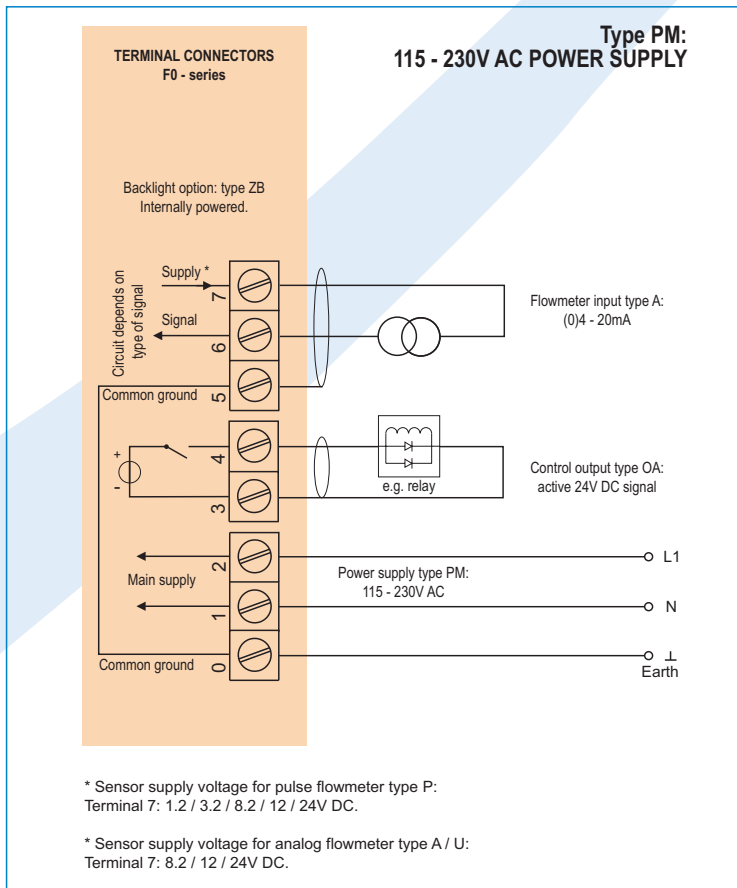

Typical wiring diagram 030-P-OR-PM-ZB

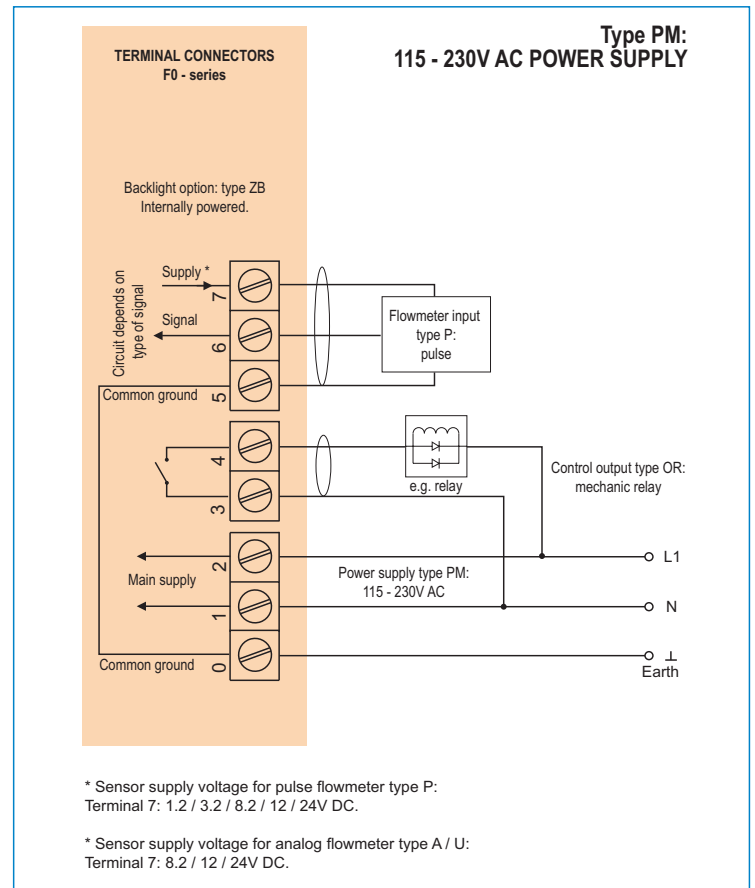

Hazardous area applications

The 5030-XI has been certified according ATEX and IECEx by KEMA for use in Intrinsically Safe applications with an ambient temperature of -40°C to +70°C (-40°F to +158°F).

- The ATEX markings for gas and dust applications are:

II 1 G Ex ia IIC T4
II 1 D Ex iaD 20 IP 65/67 T 100 °C.

- The IECEx markings for gas and dust applications are: **Ga Ex ia IIC T4** and **Ex iaD 20 IP 65/67 T100 °C.**

It is allowed to connect up to three I.S. power supplies to power the unit, sensor and back-light. The 5030-PD-XI offers a 8.2V DC sensor supply to power e.g. a Namur sensor or the input voltage to power an analog sensor.

Certificate of conformity KEMA 09ATEX0019 X

• IECEx KEM 09.0004x



Configuration example IIA - IIB and IIC - H5030-P-OT-PC-(PX)-XI-(ZB) - Battery powered unit

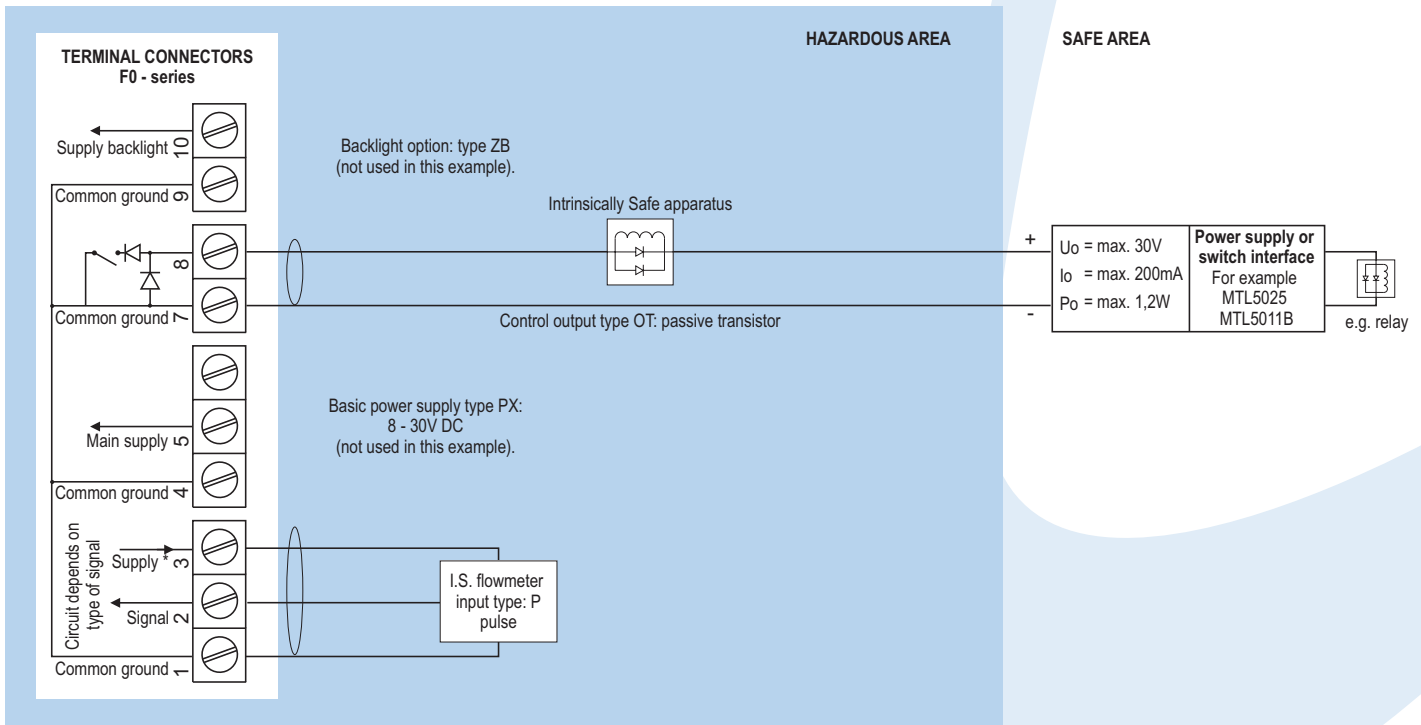

* Sensor supply voltage for pulse flowmeter type P : Terminal 3: 1.2 / 3.2V DC.
Please note: type PX may be used in combination with the battery (type PC). PX will power the unit; the battery will be disabled automatically till power is disconnected.

Configuration example IIA - IIB and IIC - H5030-P-OT-PX-XI-(ZB) - Basic power supply 8 - 30V DC

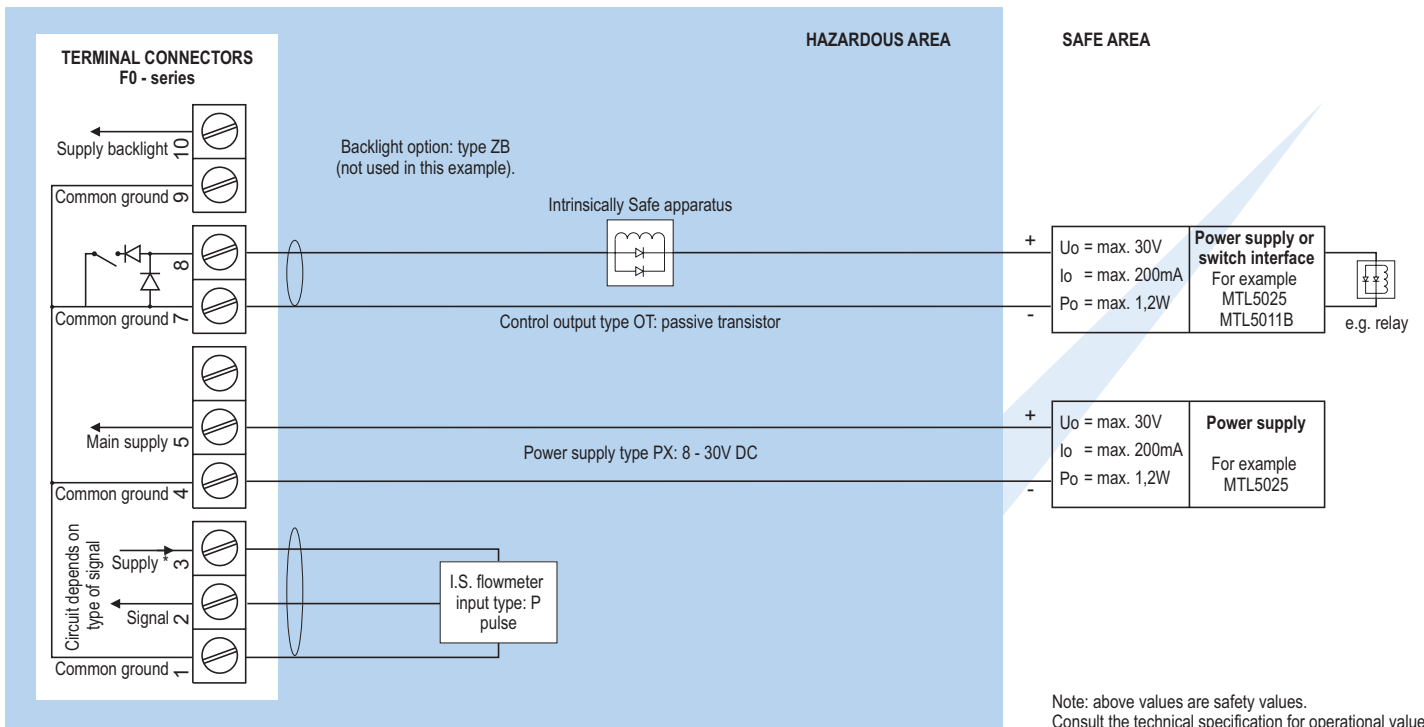

* Sensor supply voltage for pulse type P: Terminal 3: 1.2V / 3.2V DC.

Please note: type PX may be used in combination with the battery (type PC). PX will power the unit; the battery will be disabled automatically till power is disconnected.

Configuration example IIA - IIB and IIC - H5030-P-OT-PX-XI-ZB - Basic power supply 8 - 30V DC

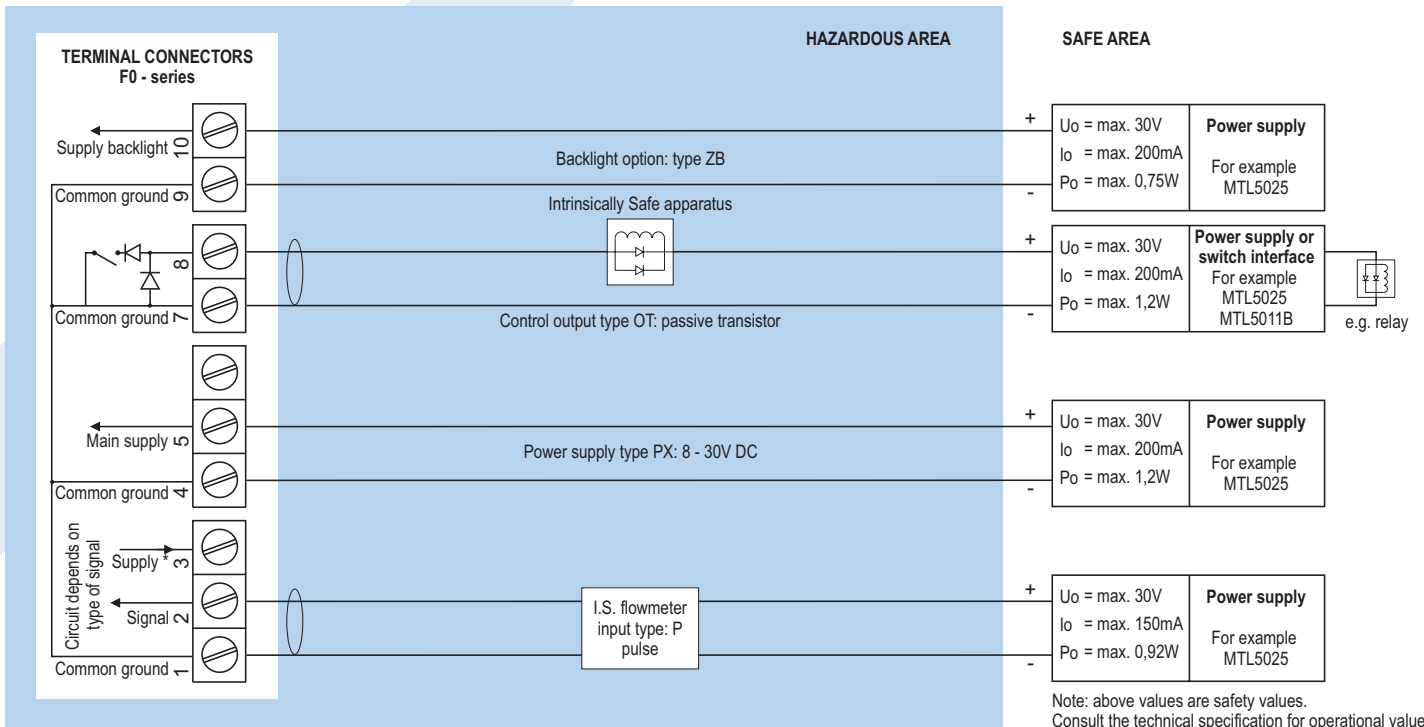

* Sensor supply voltage for pulse type P: Terminal 3: 1.2V / 3.2V DC.

Please note: type PX may be used in combination with the battery (type PC). PX will power the unit; the battery will be disabled automatically till power is disconnected.

Configuration example IIA - IIB and IIC - 5030-P-OT-PD-XI-ZB - Power supply 16 - 30V DC

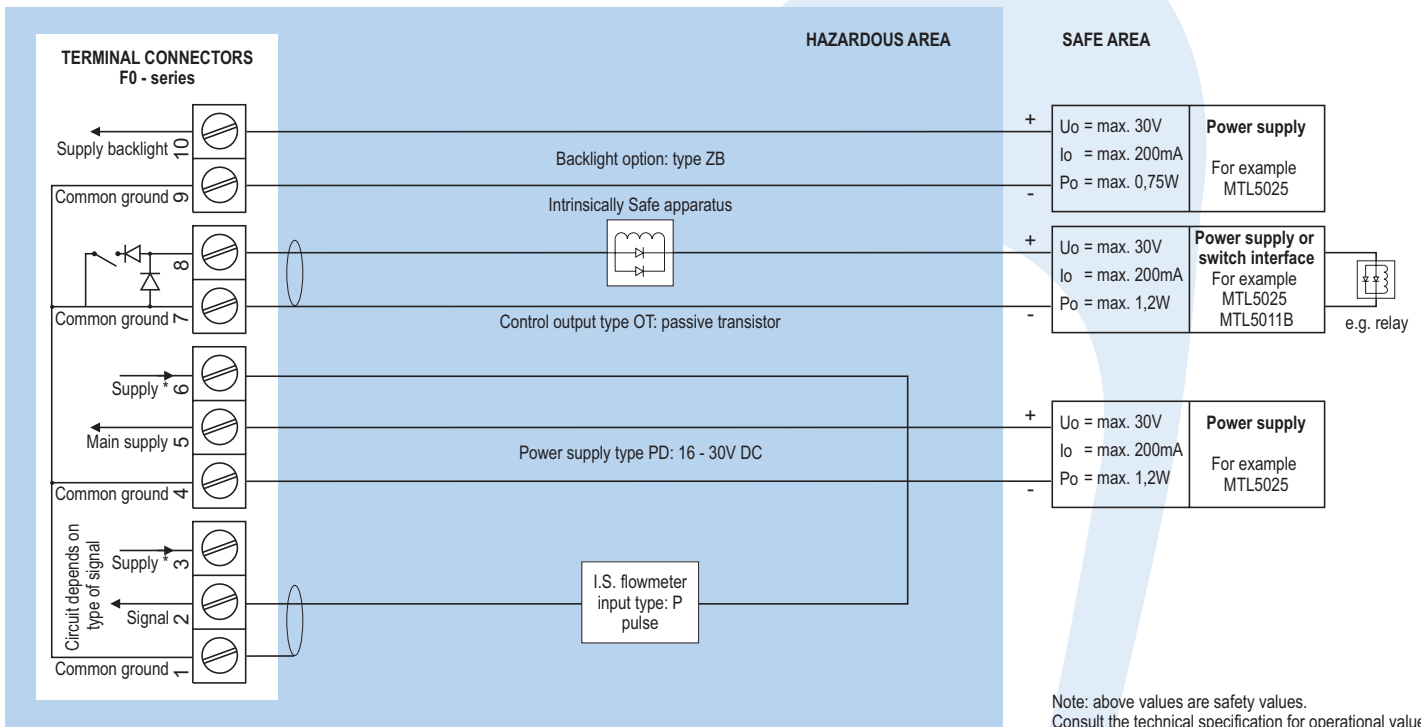

* Sensor supply voltage for pulse type P: Terminal 3: 1.2V / 3.2V DC. Terminal 6: 8.2V DC.
Please note: type PD may be used in combination with the battery (type PC). PD will power the unit; the battery will be disabled automatically till power is disconnected.

Note: above values are safety values.
Consult the technical specification for operational values.

Configuration example IIA - IIB and IIC - 5030-A-OT-PD-XI-ZB - Power supply 16 - 30V DC

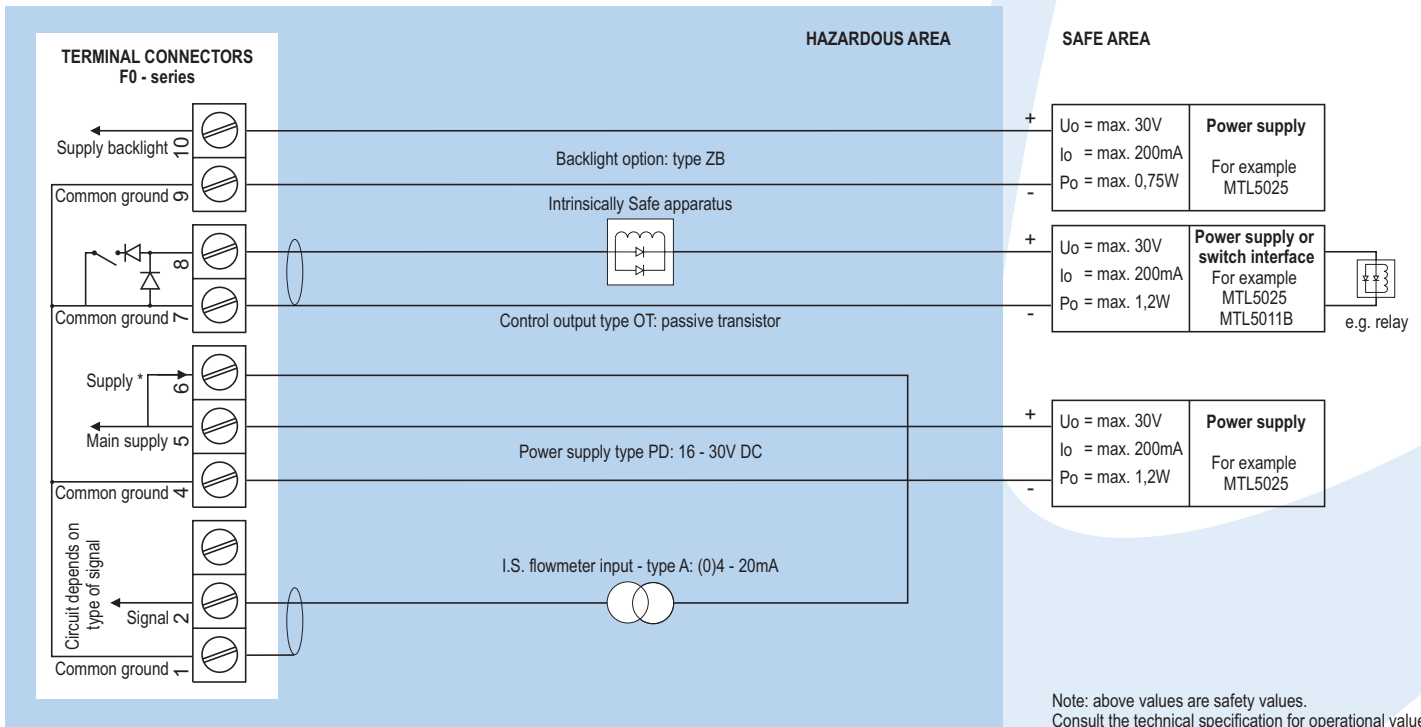

* Sensor supply voltage for analog flowmeter type A / U: Terminal 6: as input voltage terminal 5 (internally linked).
Please note: type PD may be used in combination with the battery (type PC). PD will power the unit; the battery will be disabled automatically till power is disconnected.

Note: above values are safety values.
Consult the technical specification for operational values.

Configuration example IIA - IIB and IIC - H5030-A-OT-PL-XI-ZB - Input loop powered

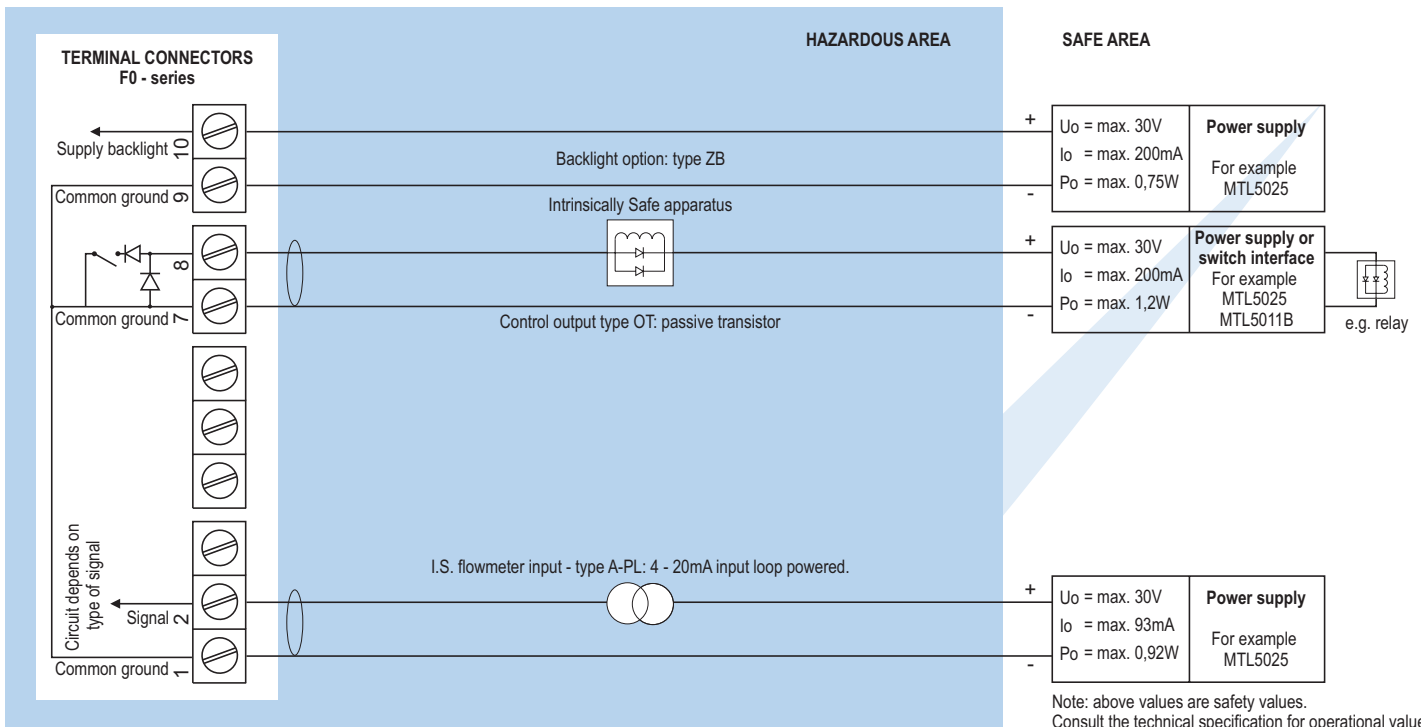

Sensor supply is not available: unit is input loop powered (type PL).
Please note: type PL may be used in combination with the battery (type PC). PL will power the unit; the battery will be disabled automatically till power is disconnected.

Configuration example IIA - IIB and IIC - H5030-A-OT-PX-XI-ZB - Basic power supply 8 - 30V DC

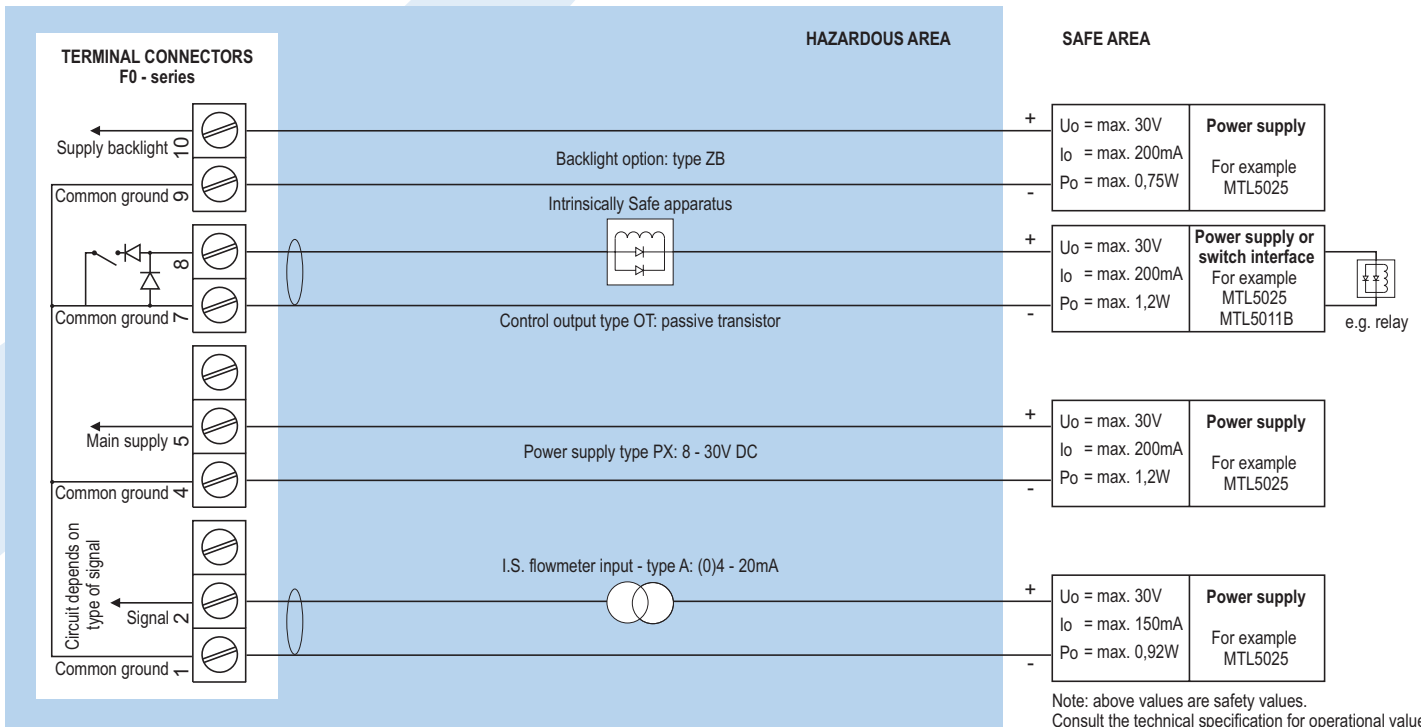

* Sensor supply voltage for analog flowmeter type A / U: not available in this example.
Please note: type PX may be used in combination with the battery (type PC). PX will power the unit; the battery will be disabled automatically till power is disconnected.

Technical specification

General

Display	
Type	High intensity reflective numeric and alphanumeric LCD, UV-resistant.
Dimensions	90 x 40mm (3.5" x 1.6").
Digits	Seven 17mm (0.67") and eleven 8mm (0.31") digits. Various symbols and measuring units.
Refresh rate	User definable: 8 times/sec. - 30 secs - off.
Option ZB	Transflective LCD with bi-color LED-backlight; green / amber. Intensity and color selected through the keyboard. Good readings in full sunlight and darkness. Also available Intrinsically Safe.

Operating temperature

Standard unit	-40°C to +80°C (-40°F to +178°F).
Intrinsically Safe	-40°C to +70°C (-40°F to +158°F).

Power requirements

Type PB	Long life Lithium battery - life-time depends upon settings and configuration - up to 5 years.
Type PC	Intrinsically Safe long life lithium battery - life-time depends upon settings and configuration - up to 5 years.
Type PD	16 - 30V DC. Power consumption max. 1 Watt.
Type PF	24V AC / DC ± 10%. Power consumption max. 15 Watt.
Type PL	Input loop powered from sensor signal 4 - 20mA (type A).
Type PM	115 - 230V AC ± 10%. Power consumption max. 15 Watt.
Type PX	8 - 30V DC. Power consumption max. 0.3 Watt.
Type ZB	20 - 30V DC. Power consumption max. 1 Watt. With type PF / PM: internally powered.
Note PB/PF/PM	Not available Intrinsically Safe.
Note PF/PM	The total consumption of the sensor, active output type OA and backlight type ZB may not exceed 400mA @ 24V DC.
Note	For Intrinsically Safe applications, consult the safety values in the certificate.

Sensor excitation

Type PB/PC/PX	3.2V DC for pulse signals and 1.2V DC for coil pick-up.
Note	This is not a real sensor supply. Only suitable for sensors with a very low power consumption like coils (sine wave) and reed-switches.
Type PD	for pulse signals: 1.2 / 3.2 / 8.2V DC - max. 5mA@8.2V DC. For analog signals, the sensor supply voltage is according to the power supply voltage connected.
Type PF / PM	With pulse input: 1.2 / 3.2 / 8.2 / 12 / 24V DC - max. 400mA @ 24V DC. With analog input: 8.2 / 12 / 24V DC - max. 400mA @ 24V DC.

Terminal connections

Type	Removable plug-in terminal strip. Wire max. 1.5mm ² and 2.5mm ² .
------	--

Data protection

Type	EEPROM backup of all settings. Backup of running totals every minute. Data retention at least 10 years.
Pass-code	Configuration settings can be pass-code protected.

Casing & cable gland entry

General

Window	Polycarbonate window.
Sealing	Silicone.
Control keys	Three industrial micro-switch keys. UV-resistant silicone keypad.

GB - Aluminum wall / field mount enclosures

General	Die-cast aluminum wall/field mount enclosure IP67 / NEMA 4X with 2-component UV-resistant coating.
Dimensions	130 x 120 x 75mm (5.12" x 4.72" x 2.95") - W x H x D.
Weight	1100 gr.
Type HA	Cable entry: 2 x PG9 and 1 x M20.
Type HM	Cable entry: 2 x M16 and 1 x M20.
Type HU	Cable entry: 3 x 1/2" NPT.

GB - GRP wall / field mount enclosures



General	GRP wall/field mount enclosure IP67 / NEMA 4X, UV-resistant and flame retardant.
Dimensions	130 x 120 x 75mm (5.12" x 4.72" x 2.95") - W x H x D.
Weight	600 gr.
Type HE	Cable entry: 2 x Ø 16mm and 1 x Ø 20mm.

GA & GC - Aluminum round wall / field mount enclosures

General	Die-cast aluminum wall/field mount enclosure IP67 / NEMA 4X with 2-component UV-resistant coating.
Dimensions	Ø 161 x 85mm (6.34" x 3.35") - Diam. x Depth.
Weight	1200 gr.
Colors	GA: Charcoal or GC: Red.
Type HM	Cable entry: 2 x M16 and 1 x M20.
Type HU	Cable entry: 3 x 1/2" NPT.

Hazardous area

Intrinsically Safe

ATEX certification	 II 1 G Ex ia IIC T4. II 1 D Ex iaD 20 IP 65 / 67 T 100 °C.
IECEx certification	 Ga Ex ia IIC T4. Ex iaD 20 IP 65 / 67 T 100 °C.
Ambient Ta	-40°C to +70°C (-40°F to +158°F).

Environment

Electromagnetic compatibility	Compliant ref: EN 61326 (1997), EN 61010-1 (1993).
-------------------------------	--

Signal input

Flowmeter sensor

Type P	Coil / sine wave (minimum 20mVpp or 80mVpp - sensitivity selectable), NPN/PNP, open collector, reed-switch, Namur, active pulse signals 8 - 12 and 24V DC.
Frequency	Minimum 0Hz - maximum 7kHz for total and flow rate. Maximum frequency depends on signal type and internal low-pass filter. E.g. reed switch with low-pass filter: max. frequency 120Hz.
K-Factor	0.000010 - 9,999,999 with variable decimal position.
Low-pass filter	Available for all pulse signals.
Option ZF	coil sensitivity 10mVpp.
Option ZG	coil sensitivity 5mVpp.
Type A	(0)4 - 20mA. Analog input signal can be scaled to any desired range within 0 - 20mA.
Type U	0 - 10V DC. Analog input signal can be scaled to any desired range within 0 - 10V DC.
Accuracy	Resolution: 16 bit. Error < 0.01mA / ± 0.05% FS. Low level cut-off programmable.
Span	0.001 / 999,999 with variable decimal position.
Update time	Four times per second.
Voltage drop	Type A: max. 2V DC @ 20mA.
Voltage drop	Type A - PL (loop powered): max. 2.6V DC @ 20mA.
Load impedance	Type U: 3kΩ.
Relationship	Linear and square root calculation.
Note	For signal type A and U: external power to sensor is required; e.g. type PD.

Signal output

Control output

Function	Control output according the batch process.
Type OA	One active 24V DC transistor output (PNP); load max. 400mA (requires PF or PM).
Type OR	One electro-mechanical relay output - isolated; max. switch power 230V AC (N.O.) - 0.5A (requires PF or PM).
Type OT	One passive transistor output (NPN) - not isolated. Max. 50V DC - 300mA per output.

Operational

Operator functions

Displayed functions	<ul style="list-style-type: none"> • Preset value - can be entered by the operator. • Batched quantity or remaining quantity. • Total and accumulated total. • Total can be reset to zero by pressing the STOP-key twice.
---------------------	---

Preset and total

Digits	7 digits.
Units	L, m ³ , GAL, USGAL, KG, lb, bbl, no unit.
Decimals	0 - 1 - 2 or 3.
Note	Total can be reset to zero.

Accumulated total

Digits	11 digits.
Units / decimals	According to selection for total.
Note	Can not be reset to zero.

Accessories

Mounting accessories

ACFo2	Stainless steel wall mounting kit.
ACFo5	Stainless steel pipe mounting kit (worm gear clamps not included).
ACFo6	Two stainless steel worm gear clamps Ø 44 - 56mm.
ACFo7	Two stainless steel worm gear clamps Ø 58 - 75mm.
ACFo8	Two stainless steel worm gear clamps Ø 77 - 95mm.
ACFo9	Two stainless steel worm gear clamps Ø 106 - 138mm.
ACF10	Customized Grevopal tagplates for ACFo2 and ACFo5, including stainless steel screws. Dimension: 95mm x 12.5mm (3.75" x 0.50").

Display example - 90 x 40mm (3.5" x 1.6")

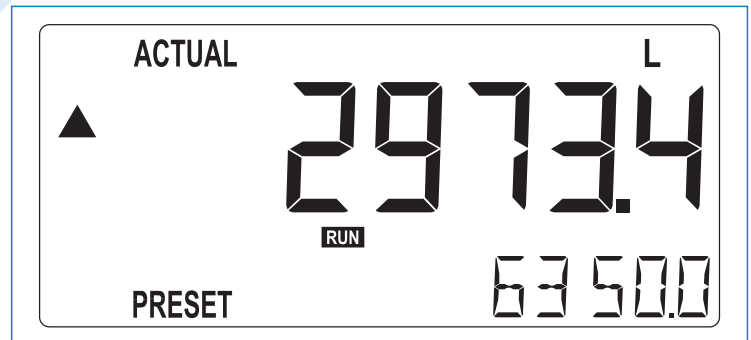

Ordering information

Standard configuration: ERB & RA030, RG030 full part number breakdown

ordering information:	G	-	030	-	H	-	O	-	P	-	X	-	Z
Enclosures - IP67 / NEMA4X													
GA	⊗	Aluminum round enclosure, color Charcoal.											
GB	⊗	Aluminum or GRP enclosure.											
GC	⊗	Aluminum round enclosure, color Red.											
Flowmeter Sensor input signal													
P	⊗	Pulse input: coil, npn, pnp, namur, reed-switch.											
Cable entry for GB - GRP field / wall mount enclosures													
HE	⊗	Cable entry: 2 x Ø 16mm											
Cable entry for GB - Aluminum field / wall mount enclosures													
HA	⊗	Cable entry: 2 x PG9 + 1 x M20.											
HM	⊗	Cable entry: 2 x M16 + 1 x M20.											
HU	⊗	Cable entry: 3 x 1/2" NPT.											
Cable entry for GA & GC - Aluminum round field / wall mount enclosures													
HM	⊗	Cable entry: 2 x M16 + 1 x M20.											
HU	⊗	Cable entry: 3 x 1/2" NPT.											
Output													
OA		One active transistor output - requires PF or PM.											
OR		One mechanical relay output - requires PF or PM.											
OT	⊗	One passive transistor output - standard configuration.											
Power supply													
PB		Lithium battery powered.											
PC	⊗	Lithium battery powered - Intrinsically Safe.											
PD	⊗	16 - 30V DC + sensor supply.											
PF		24V AC / DC + sensor supply.											
PL	⊗	Input loop powered from sensor signal type "A".											
PM		115 - 230V AC + sensor supply.											
PX	⊗	Basic power supply 8 - 30V DC (no real sensor supply).											
Hazardous area													
XI	⊗	Intrinsically Safe, according ATEX and IECEx.											
XX		Safe area only.											
Other options													
ZB	⊗	Backlight.											
ZF	⊗	Coil input 10mVpp.											
ZG	⊗	Coil input 5mVpp.											
ZX	⊗	No options.											

The bold marked text contains the standard configuration.

⊗ Available Intrinsically Safe.

Specifications are subject to change without notice.